



ELEGANT

FURNITURE & LIGHTING™

Installation manual for 3503G7LBK

Dimensions : D40.6"H38.3"

Collection : Monroe

Bulb Type : LED PCB 232W 3000K

Lamp Weight :126.5LBS

Total Weight :136.4LBS



Thank you for choosing our product(s).

Our Company is actively involved in every step of the production.

Our product(s) are designed to be utilized for every application that graces your home or business.

We pride ourselves in providing the most prompt and courtesy service to all of the valued customers.

Please find the enclosed detailed instruction and read carefully for proper installation.

If you have any questions, please contact the retailer

Where the purchased was made.



SAFETY

Warning: MAKE SURE THE ELECTRICITY TO THE WIRES YOU ARE WORKING ON IS SHUT OFF. BY EITHER REMOVING THE FUSE OR TURNING OFF THE CIRCUIT BREAKER.

CAUTION

- Before assembling the lighting fixture, please read all instructions carefully.
- All frame & crystal components are fragile, please handle with care.
- Required supply circuit : 110 - 130V/60Hz
- Labeled wires are "L" for live wire, "N" for neutral wire, "E" for ground wire.
- Never install fixture on damp ceiling, the room should be dry and well ventilated
- All electrical components must be installed by a licensed electrician and in accordance with the National Electrical Code and the appropriate local electrical codes.

Unpack the Package

Please open the box carefully and check all the items are inside the box. If you have any installation, assembling and missing parts questions. where you purchase from and any other relevant information ready, our customer service team will provide comprehensive and worry free service to our valued customers.

Frame Assembly Diagram

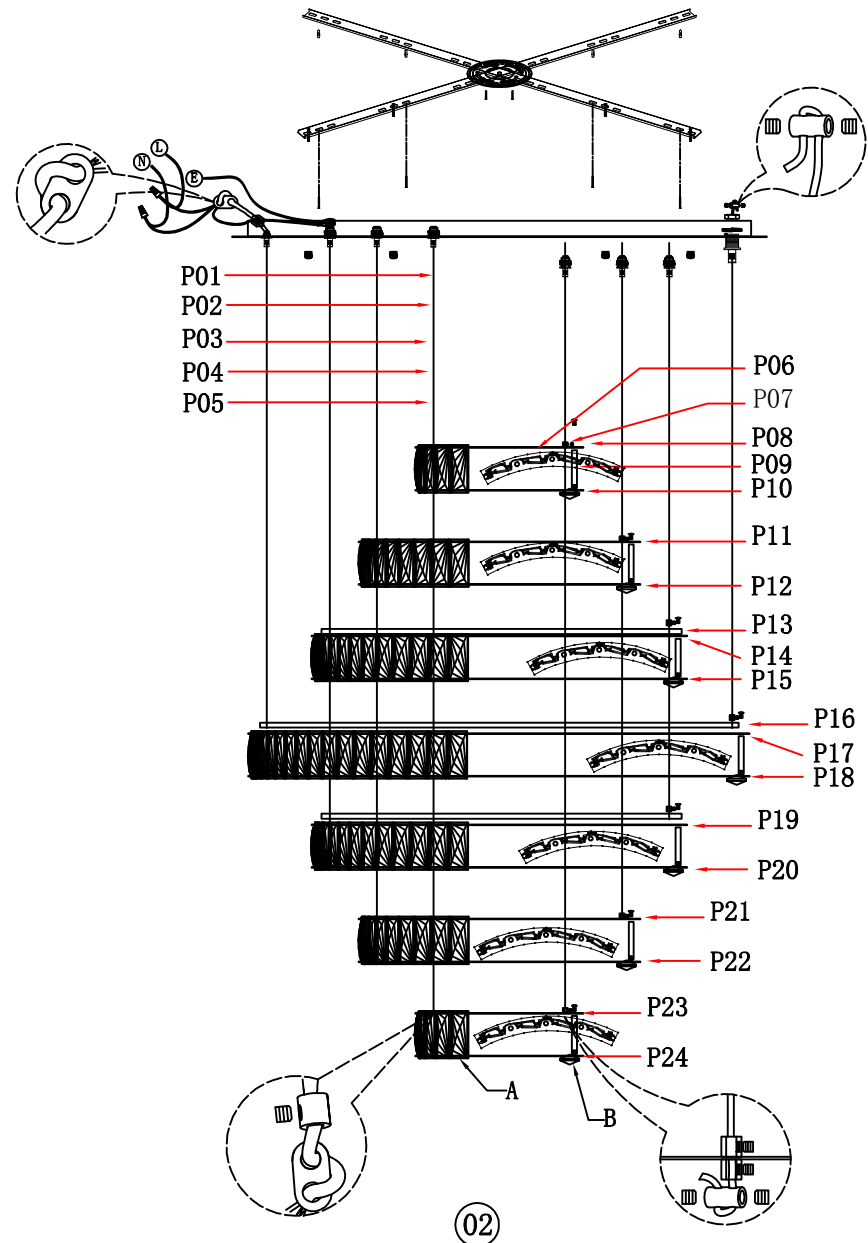









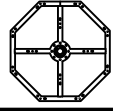
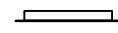



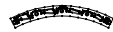

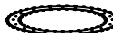
3503G7LBK D40.6"H38.3"

Step 1





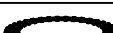











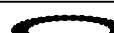

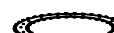

Please use the partslist to ensure you are not missing any parts.

PARTS LIST

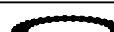
Parts number	Picture	Description	Qty	Diagram number
MB9R70		Ceiling Plate	1	ZA
P-3503G7LBK-1		canopy	1	ZB
		connector	30	ZC
		M5 screw cap	12	ZD
P-3503G7LBK-2		ssl 2*24#03.6mm*118.2" electric wire	2	P01
		ssl 2*24#03.6mm*137.8" electric wire	1	P02
		4W high voltage LED PCB	5	P06
		D8*H8 wire fixer	3	P07
		D15.8"upside iron slice	1	P08
		2.4" metal pipe	10	P09
		D15.8"downside S.S slice	1	P10
P-3503G7LBK-3		ssl 2*24#03.6mm*118.2" electric wire	3	P01
		ssl 2*24#03.6mm*137.8" electric wire	1	P02
		4W high voltage LED PCB	7	P06
		D8*H8 wire fixer	4	P07
		D23.6"upside iron slice	1	P11
		2.4" metal pipe	14	P09
		D23.6"downside S.S slice	1	P12













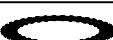

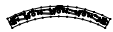

03

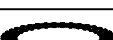
3503G7LBK D40.6"H38.3"

Parts number	Picture	Description	Qty	Diagram number
P-3503G7LBK-4		ssl 2*24#03.6mm*126" electric wire	3	P03
		ssl 2*24#03.6mm*137.8" electric wire	1	P02
		4W high voltage LED PCB	10	P06
		D8*H8 wire fixer	4	P07
		D30.1" pipe ring	1	P13
		D31.5"upside iron slice	1	P14
		2.4" metal pipe	20	P09
		D31.5"downside S.S slice	1	P15
P-3503G7LBK-5		ssl 2*24#03.6mm*126" electric wire	7	P03
		ssl 2*24#03.6mm*137.8" electric wire	1	P02
		4W high voltage LED PCB	14	P06
		D8*H8 wire fixer	8	P07
		D39.8" pipe ring	1	P16
		D40.6"upside iron slice	1	P17
		2.4" metal pipe	28	P09
		D40.6"downside S.S slice	1	P18
	P-3503G7LBK-6		ssl 2*24#03.6mm*141.8" electric wire	3
		ssl 2*24#03.6mm*149.6" electric wire	1	P05
		4W high voltage LED PCB	10	P06
		D8*H8 wire fixer	4	P07
		D30.1" pipe ring	1	P13

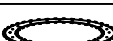
04

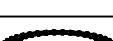
3503G7LBK D40.6"H38.3"

Parts number	Picture	Description	Qty	Diagram number
P-3503G7LBK-6		D31.5"upside iron slice	1	P19
		2.4" metal pipe	20	P09
		D31.5"downside S.S slice	1	P20
P-3503G7LBK-7		ssl 2*24#03.6mm*141.8" electric wire	3	P04
		ssl 2*24#03.6mm*149.6" electric wire	1	P05
		4W high voltage LED PCB	7	P06
		D8*H8 wire fixer	4	P07
		D23.6"upside iron slice	1	P21
		2.4" metal pipe	14	P09
		D23.6"downside S.S slice	1	P22
P-3503G7LBK-8		ssl 2*24#03.6mm*141.8" electric wire	2	P04
		ssl 2*24#03.6mm*149.6" electric wire	1	P05
		4W high voltage LED PCB	5	P06
		D8*H8 wire fixer	3	P07
		D15.8"upside iron slice	1	P23
		2.4" metal pipe	10	P09
		D15.8"downside S.S slice	1	P24
RC620-3-CL		1.2"*3"crystal	805	A
RC2020-30-CL		1.2"*1.2"crystal	332	B

05

3503G7LBK D40.6"H38.3"

Step 2

Canopy Installation Instruction

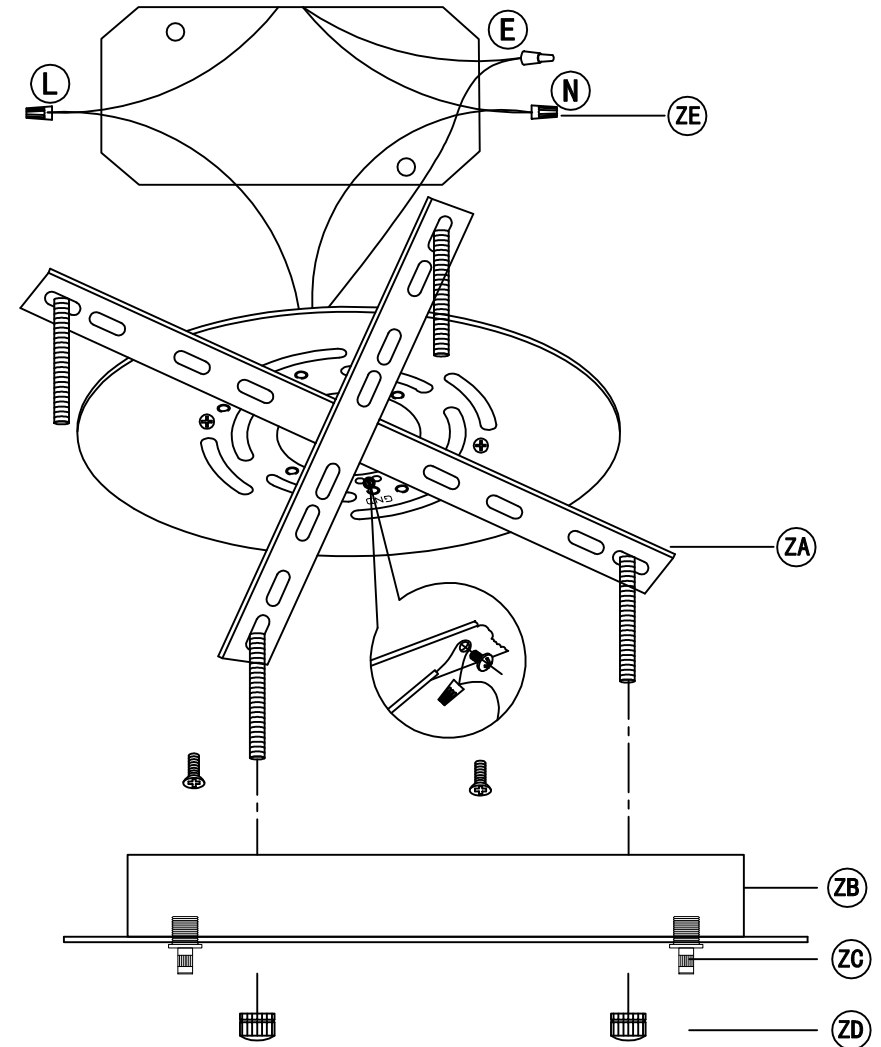

06

IMPORTANT: Test sockets with bulb before dressing the fixture.

1. Use two screws (ZG) to fix the Ceiling Plate (ZA) on the ceiling; which are not supplied and should already be in your box.
2. Be sure when connecting the wire use electrician approved junction caps (ZE).
3. Stow the excess wire in the canopy (ZB).
4. Align the canopy (ZB) with the hanging plate screw, fix the lamp on the ceiling, tighten and fix it with a M5 screw cap (ZD).

5. If you need to cut the wire, please find the label "

	L=Black wire		L=Black wire
(1)		to	(7)
	N=White Wire		N=White Wire

on the ceiling plate, it is the main line of power. After adjusting the wires, please use them to connect the "N" and "L" wires to power.

Step 3

Frame Assembly Diagram

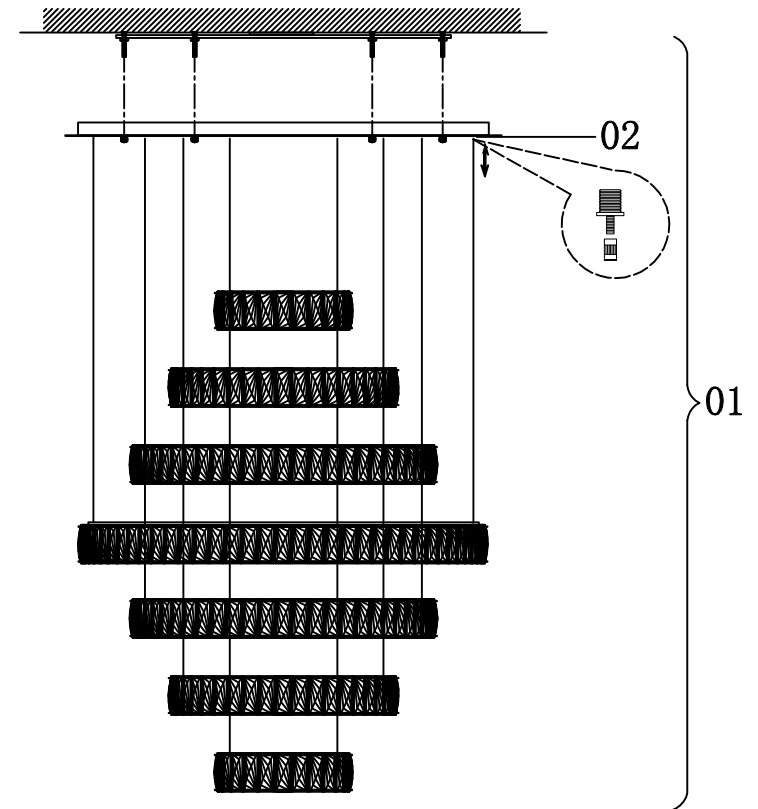

Frame Assembly Instructions

Installation:

Please read all instructions carefully. Before you proceed to install, make sure that the power supply is turned off and remains off until installation is complete. Please note that each part has been assigned a number. Please proceed in a numerical order.

1. Fixed the Ceiling Cover on the Mounting Bracket , then put the screws tightened.
2. Please unscrew the connector (02) of the expansion part before adjusting the line, and then screw on the cap after adjusting the line.

Crystal Dressing Diagram

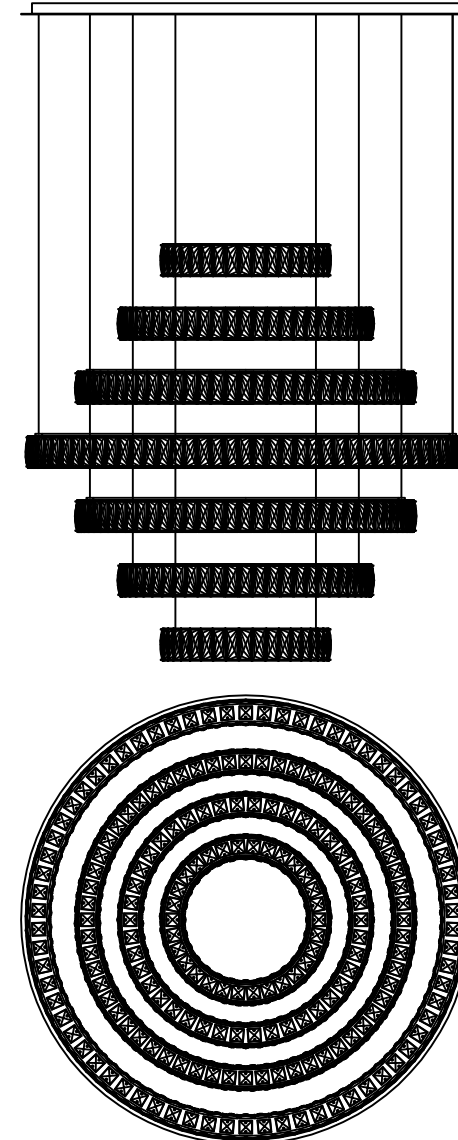

Congratulations !

You are now done installing your Elegant Lighting fixture. Sit back and admire each crystal as it will become the statement piece for your room/house.

Thank you.

Cleaning and Maintenance of Chandelier Frame

The finish on our chandelier frames and fixture frames is protected by a durable coating of lacquer. To clean, use a clean soft, dry cloth. Do not use any metal polishes, cleaners, abrasives or any substance which could remove the protective finish. Failure to follow these instructions automatically voids the guarantee.

Cleaning and Maintenance of Crystals

Wet a soft cotton fabric in clean warm water and wipe gently, then polish with a dry soft cotton fabric.

To Order Crystal Replacement Parts

Should you require replacement crystals or pins (the metal connectors attaching the crystals), contact the store where the product was purchased or contact us . For ease of ordering, you may use the original crystal trimming instructions provided with this product and circle the items you wish to order, indicating the quantity by writing the number needed adjacent to the circle . You will be contacted with prices prior to shipment. All orders must be pre-paid.

3503G7LBK D40.6"H38.3"

Elegant Lighting Warranty

The finish and frame of your new chandelier or fixture are warranted for a period of one (1) year from the date of purchase. Our company will, at its option, repair or replace any frame that has a defect in the materials or workmanship during the warranty period. All crystals are guaranteed for their original quality during the life of the chandelier. Breakage is not covered by this warranty.

To make a claim under this warranty, contact our customer service department.

A written return authorization form will be sent to you with specific instructions.

3503G7LBK D40.6"H38.3"

Returns and Conditions of Warranty

Returns must be pre-authorized by contacting our customer service department. Returns will only be accepted with a written return merchandise authorization and return shipping charges pre-paid. We reserve the right to inspect all returned merchandise to fully determine the nature of any defect. This guarantee shall not apply to any product that has been changed, altered or otherwise modified, nor shall it apply to any product that has been repaired or altered by anyone other than a pre-authorized facility. We will not be responsible for any breakage or damages incurred during transit, nor for crystal parts or metal frame part that have been subject to misuse, negligence, accident or inappropriate handling. Also, we will not be held responsible for damage incurred during improper installation or wiring by others, nor for damages resulting from a failure to follow the recommended maintenance or installation procedures. This guarantee is issued in lieu of any and all other guaranteed or warranty, whether written or implied and any and all other obligations or liabilities. Further, we neither authorize nor permit any other person or firm to assume for us, any liability in connection with the sale of our products.